













50 Nm

Heavy Duty Window Wiper

Ideal for average to high speed vessels

-  Pantograph and pendulum
-  Low maintenance
-  Silent Running
-  Arms with blades up to 39ins. (1000mm) available for average speed vessels
-  Arms with blades up to 24ins. (610mm) available for high speed vessels
-  Fixed arc or variable arc models
-  12 and 24 volt DC
-  Two speeds
-  Self parking facility
-  Insulated earth return and EMC filter are standard
-  Operated by various controls including a rotary switch, toggle switch, rocker switch or a multi-speed / function control system

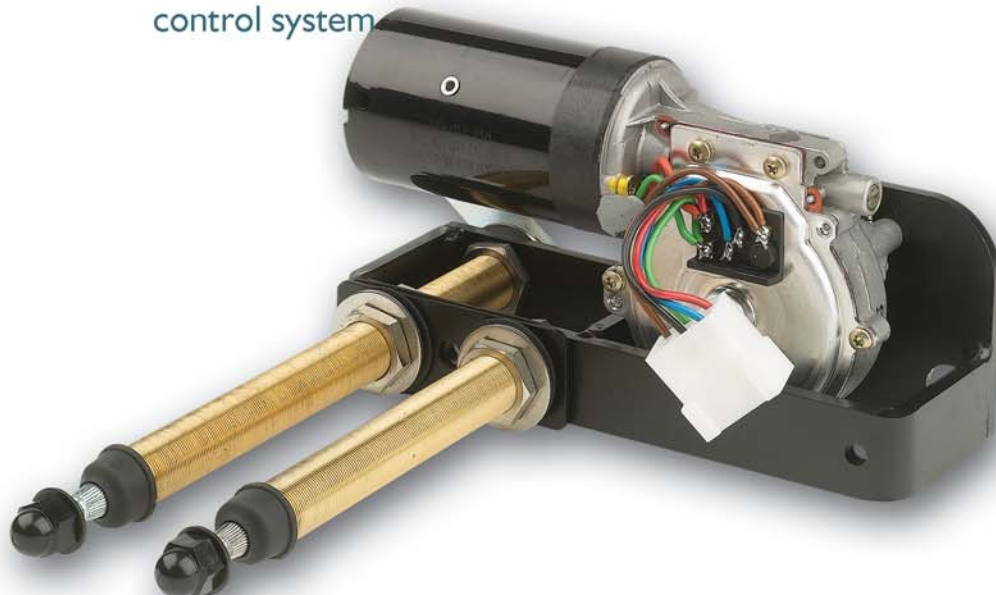



50 Nm Heavy Duty Window Wiper

Ideal for average to high speed vessels

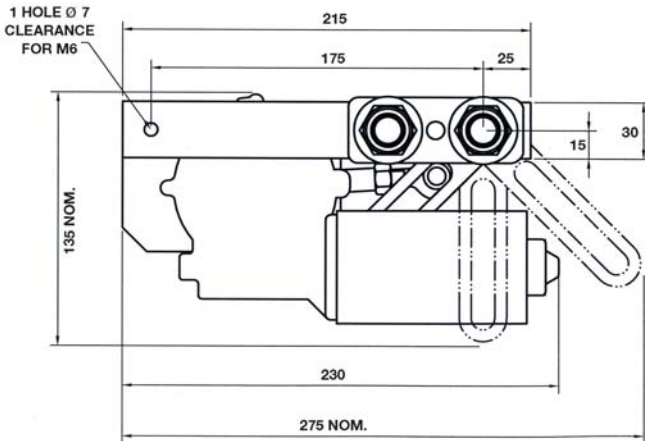

Specifications

Standard Details	2 Speed; Self Parking; Insulated Earth Return; 12v and 24v
Angles of Arc - Fixed	
Pantograph Units	25° to 90° (in 5° increments only)
Pendulum Units	25° to 115° (in 5° increments only)
Angles of Arc - Variable	
Pantograph Units	35°, 40°, 45°, 50°, 55°, 60°, 70°, 80°, 90°
Pendulum Units	35°, 40°, 45°, 50°, 55°, 60°, 70°, 80°, 90°, 100°, 110°, 120°
Spindle Centres	Between Drive Liner & Idler = 50mm Pantograph Units only
Drive Liner	M20 - Brass Liner / 12mm SS Spindle Pantograph & Pendulum Units
Liner Overall Length	Bulkhead Thickness + 120mm Liners over 125mm are available at extra cost
Idler Liner	M20 - Brass Liner / 12mm SS Spindle Pantograph Units only
Bracket	C - Compact Bracket
Unit Weight	Allowing for the maximum arm and blade lengths: 4Kgs (8.8 lbs)

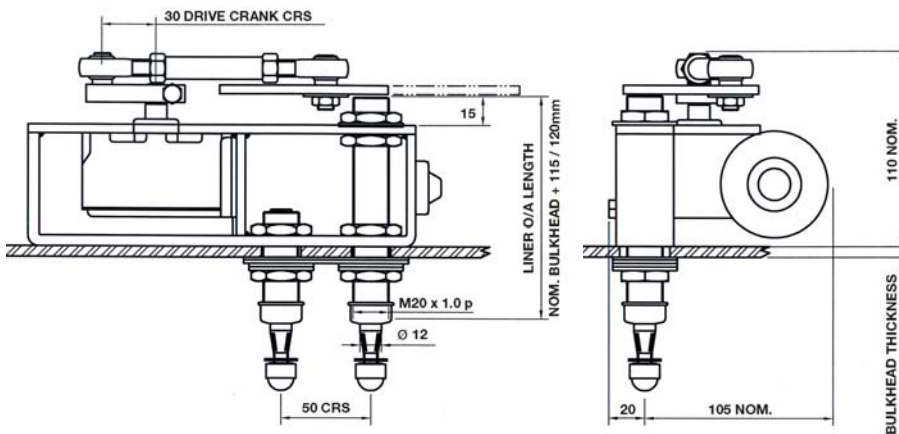

50Nm Linkage configurations

When very wide or multiple windows are to be swept we offer a comprehensive range of swept area solutions utilising the 50Nm drive unit operating either two or three arms and blades of one motor. This offers customers the benefit of simpler installations as well as cost saving.

Wiper Arms and Blades

■ Pantograph Arms

P615	Medium Duty
Lengths	12" to 34" (310mm to 860mm) nom
Drive Head	12mm
Idler Head	12mm
Blade Clip	14mm
P620	Medium Duty
Lengths	12" to 34" (310mm to 860mm) nom
Drive Head	12mm
Blade Clip	20mm

■ Pendulum Arms

F63	Medium Duty
Lengths	12" to 34" (310mm to 860mm) nom
Drive Head	12mm
Blade Clip	14mm
F73	Medium Duty
Lengths	12" to 34" (310mm to 860mm) nom
Drive Head	12mm
Blade Clip	20mm

■ Blades

B140	Curved Blade
Lengths	12" to 28" (310mm to 710mm) nom
For use with arm types:	
Pendulum	F63
Pantograph	P615
B140	Curved Blade
Lengths	32" (810mm), nom
For use with arm types:	
Pendulum	F73
Pantograph	P620



B. HEPWORTH
AND COMPANY LIMITED

2-4 Merse Road, North Moons Moat, Redditch, Worcestershire B98 9HL
T +44 (0) 1527 61243 F +44 (0) 1527 66836 E bhepworth@b-hepworth.com

www.b-hepworth.com

